

P.O.		LOCATION:		
DOOR NO.:		WIDTH (INCHES)	NET FRAME (INCHES)	
SERIES:	6000H - S - HINGED SINGLE DOOR	RO	WIDTH	HEIGHT
DATE MODIFIED:	08-11-2016			

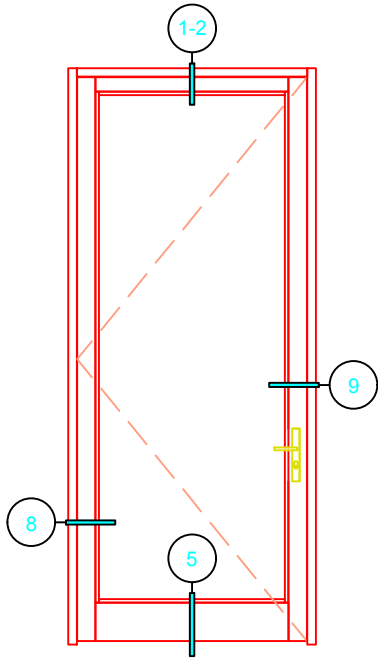

SINGLE DOOR

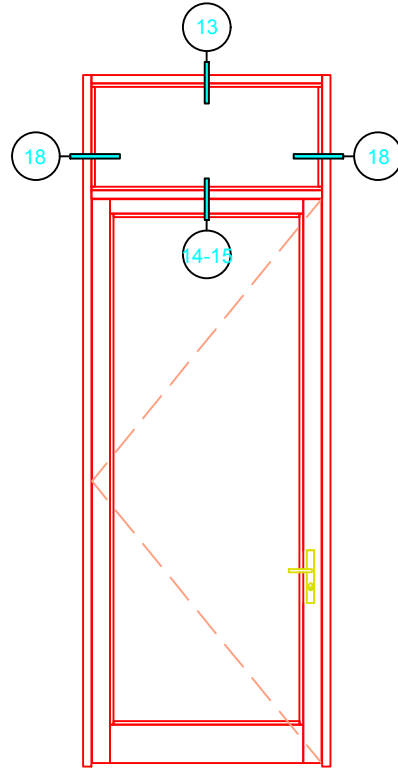

SINGLE DOOR W/ TRANSOM

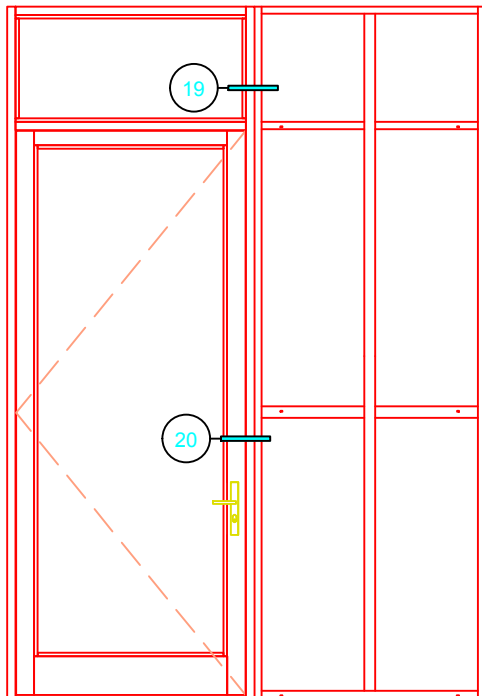

SINGLE DOOR W/ TRANSOM & SIDE LIGHT

### CONFIGURATION:

#### HINGE LOCATION

LEFT HINGED

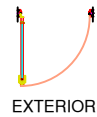

RIGHT HINGED

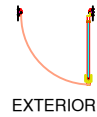

#### SWING DIRECTION

SWING IN

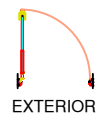

SWING OUT

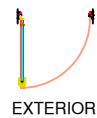

P.O.		LOCATION:		
DOOR NO.:		WIDTH (INCHES)	NET FRAME (INCHES)	
SERIES:	6000H - S - HINGED SINGLE DOOR	RO	WIDTH	HEIGHT
DATE MODIFIED:	08-11-2016			

1

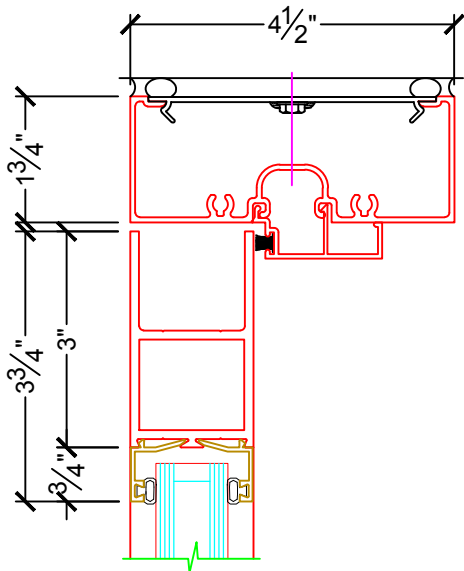

2

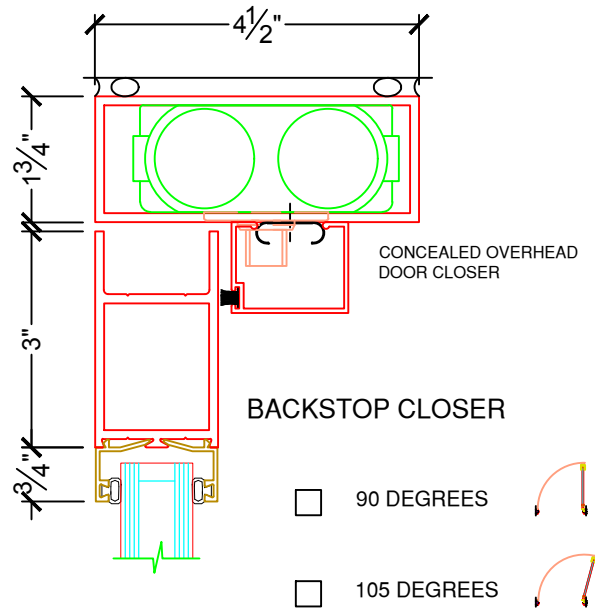

5

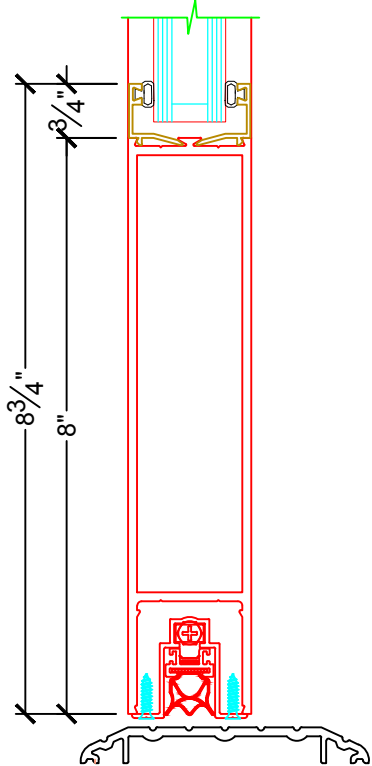

P.O.		LOCATION:		
DOOR NO.:		WIDTH (INCHES)	NET FRAME (INCHES)	
SERIES:	6000H - S - HINGED SINGLE DOOR	RO	WIDTH	HEIGHT
DATE MODIFIED:	08-11-2016			

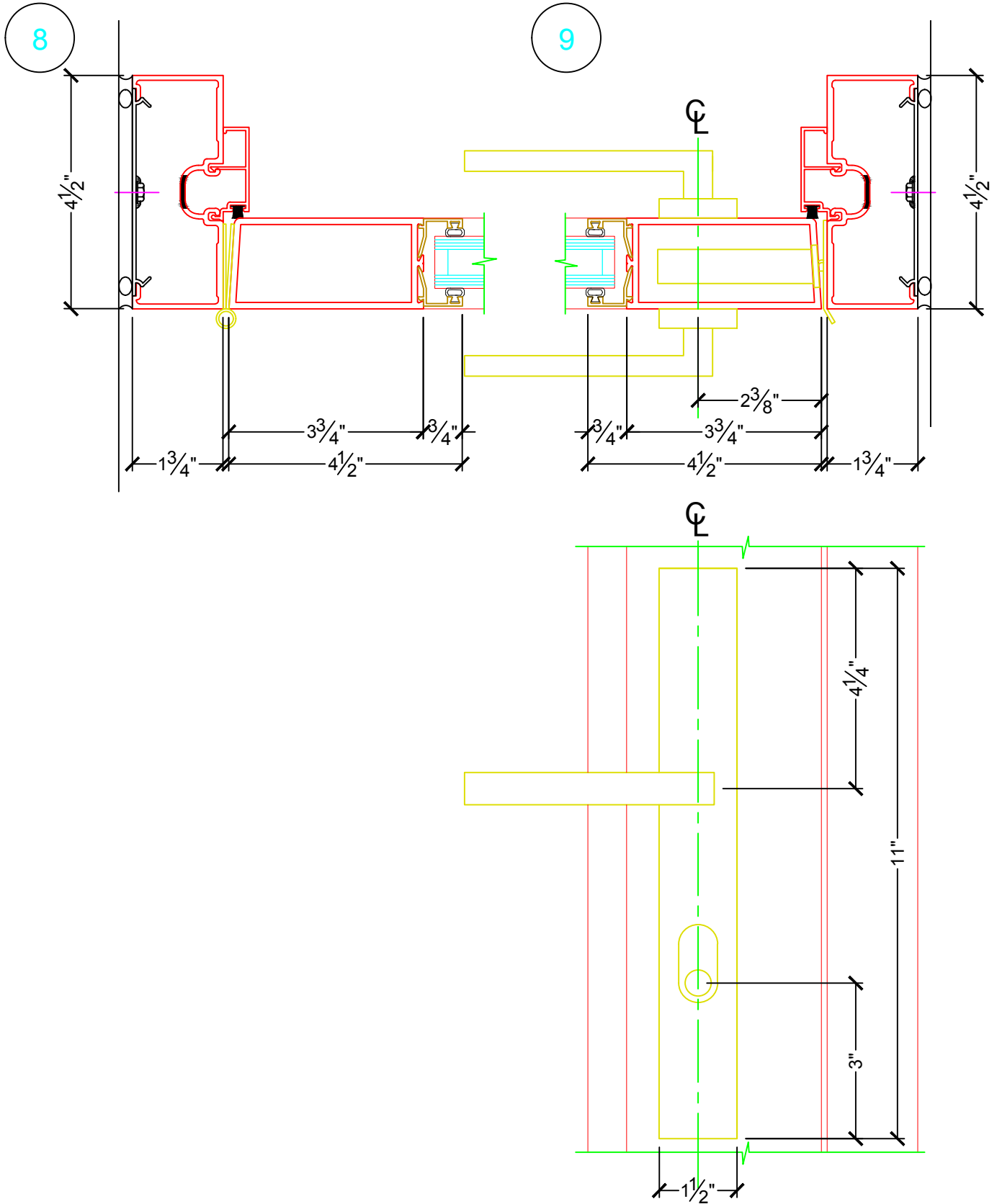

P.O.		LOCATION:		
DOOR NO.:		WIDTH (INCHES)	NET FRAME (INCHES)	
SERIES:	6000H - S - HINGED SINGLE DOOR	RO	WIDTH	HEIGHT
DATE MODIFIED:	08-11-2016			

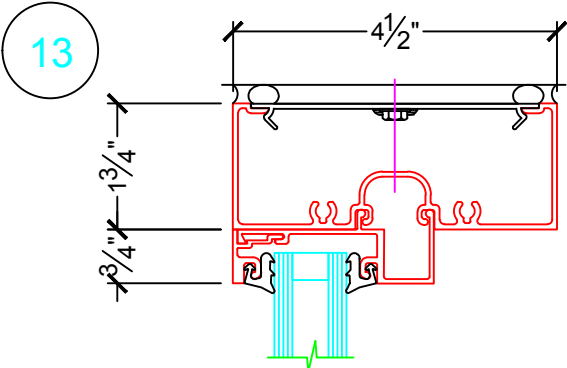

BACKSTOP CLOSER

- 90 DEGREES
- 105 DEGREES

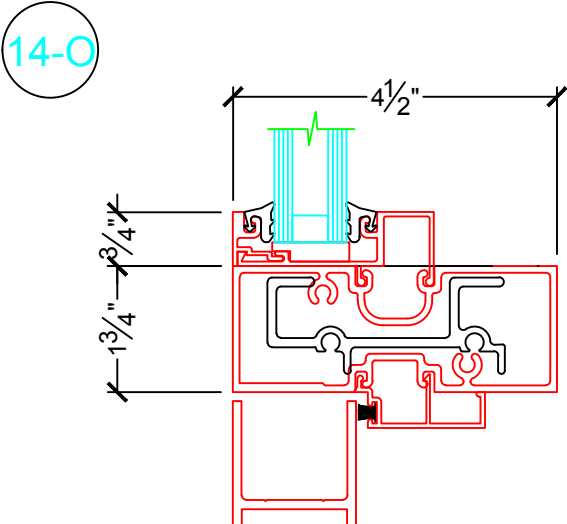

SWING OUT ONLY

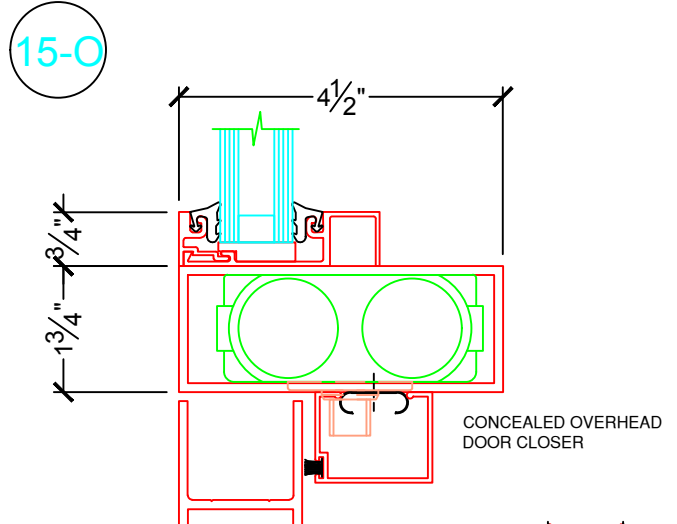
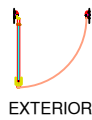

SWING OUT ONLY

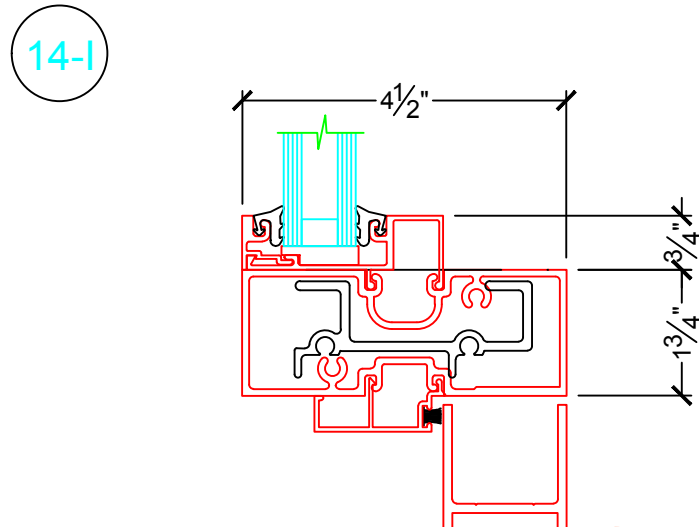
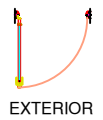

SWING IN ONLY

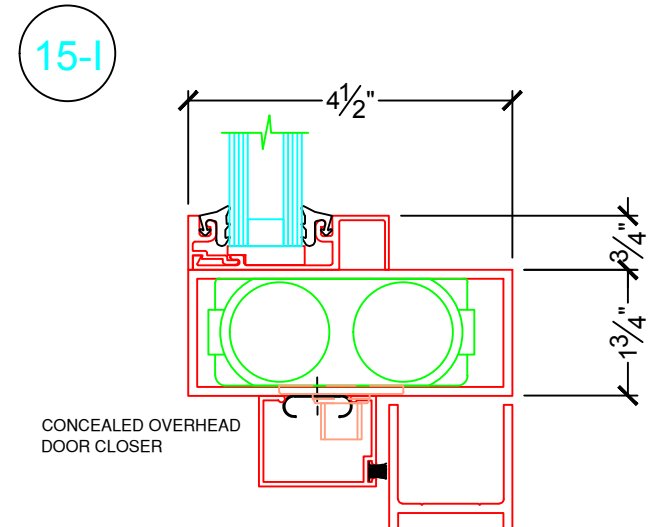

SWING IN ONLY

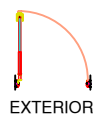

P.O.		LOCATION:		
DOOR NO.:		WIDTH (INCHES)	NET FRAME (INCHES)	
SERIES:	6000H - S - HINGED SINGLE DOOR	RO	WIDTH	HEIGHT
DATE MODIFIED:	08-11-2016			

18

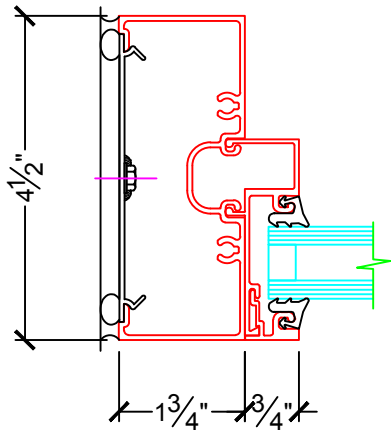

18

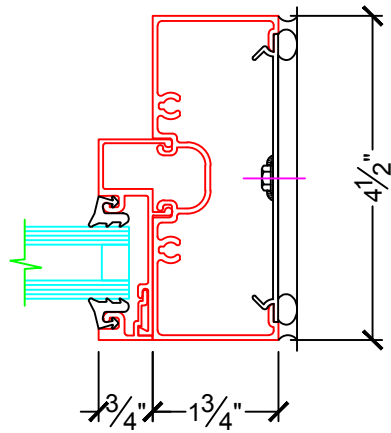

19

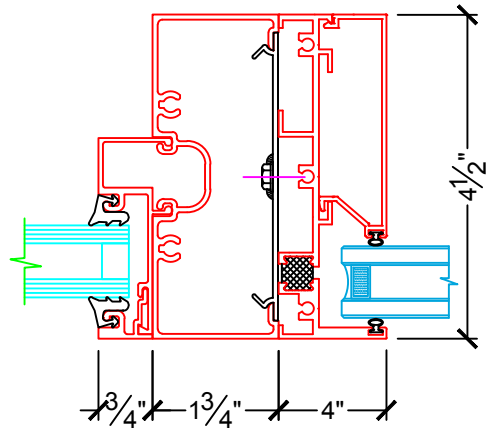

P.O.		LOCATION:		
DOOR NO.:		WIDTH (INCHES)	NET FRAME (INCHES)	
SERIES:	6000H - S - HINGED SINGLE DOOR	RO	WIDTH	HEIGHT
DATE MODIFIED:	08-11-2016			

20-0

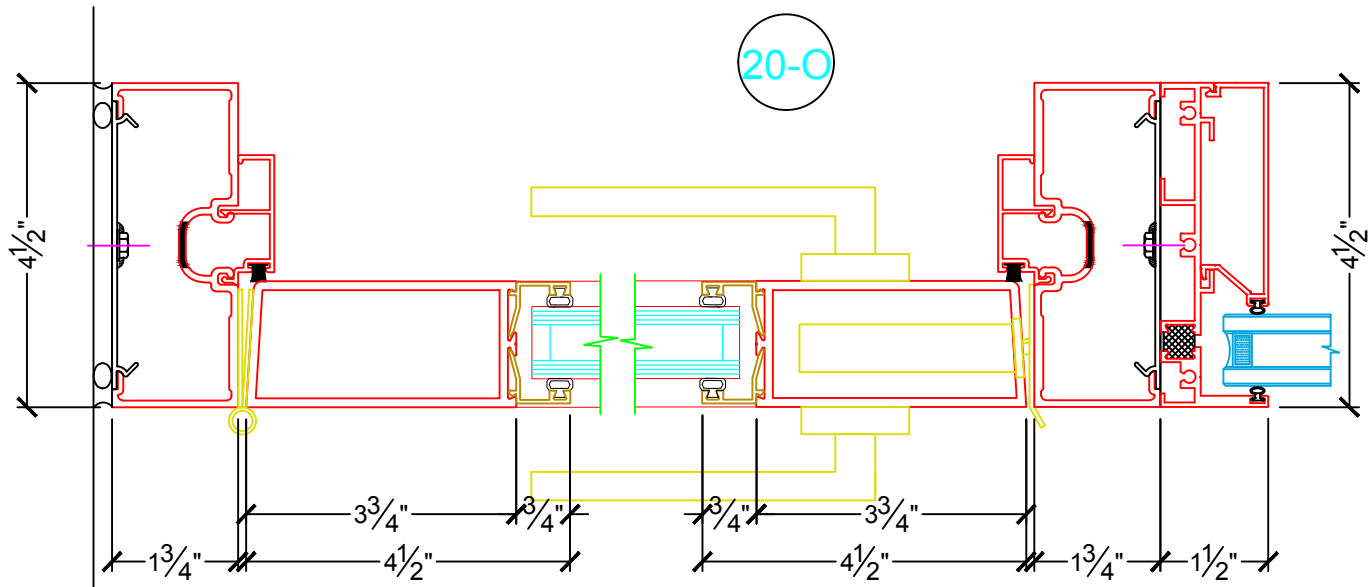

SWING DIRECTION

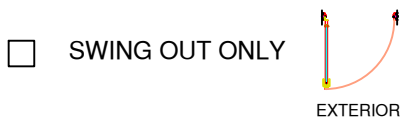

20-1

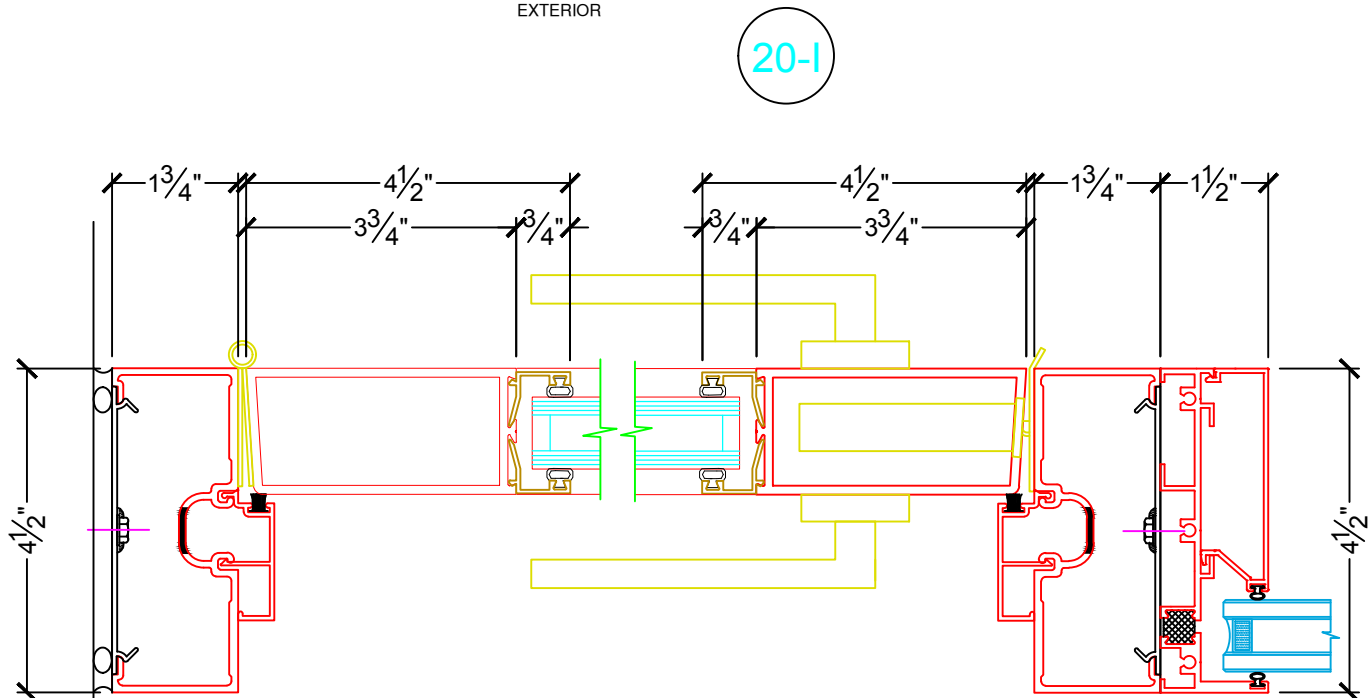

SWING DIRECTION

